

Article number: 201580M830MT

Description: E+G Screw GN 1580-M8-30-MT-H
Hygienic design

Measures

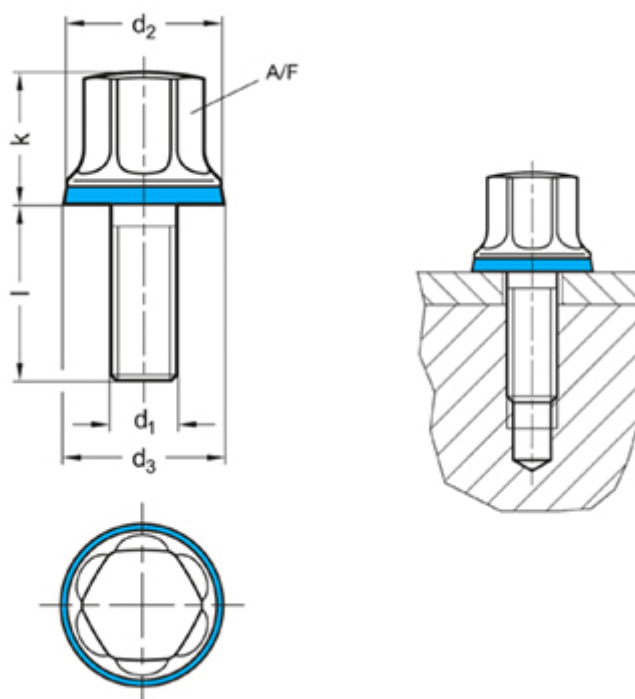

d1	= M 8
d2	= 18
d3	= 18.8
k	= 14.5
L	= 30
t min	= -
Weight in (g)	= 26